

# MCX-8

## 8-Output Expander for the MCR-308 Receiver



## Installation Instructions

### 1. INTRODUCTION

#### 1.1 General Description

The MCX-8 is an 8-output expander unit especially designed to increase the number of outputs of the MCR-308 PowerCode wireless receiver.

Up to three MCX-8 expanders, with 8 outputs each, can be connected to the MCR-308 (see Figure 1). The expanders communicate with the receiver via a 4-wire power/data bus.

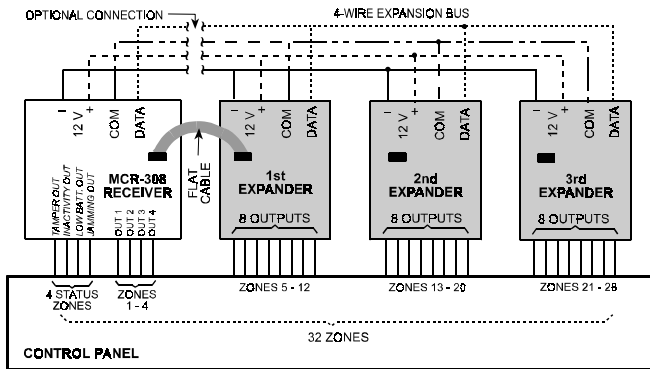

Figure 1. Full System Configuration - MCR-308 with 3 Expanders

Each expander is identified by a factory programmed 8-bit ID number. This ID must be registered in a specific memory location of the MCR-308 to which the expander is connected (see Publication DE3191-).

The communication link between the MCX-8 and MCR-308 receiver is continuously monitored (every 5 seconds) by the MCR-308 receiver. In case of communication failure, the inactivity output of the receiver will be activated.

#### 1.2 Construction and Packaging

The MCX-8 printed circuit board is enclosed in a plastic cabinet that facilitates installation on a flat surface and protects the unit against tampering. The cabinet can be separated into two parts: the cover and the base (see Figure 2). Disassembly instructions are given in Para. 3.1.

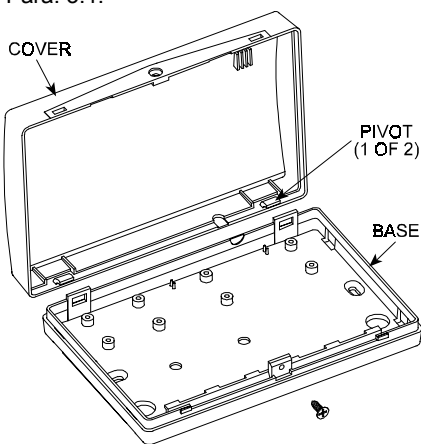

Figure 2. Plastic Cabinet

The base can accommodate a single MCX-8 module (Figure 3) or two side-by-side MCX-8's (Figure 4) or an MCR-308 receiver unit alongside the MCX-8 (Figure 5). Various mounting and wiring knockouts are provided (see Fig. 3).

Tamper protection is accomplished with an on-board tamper switch, actuated upon removal of the front cover (Figure 6). If two

units are installed in the same cabinet, only one tamper switch is used (the one of the unit to the right).

**Important!** You must bridge the two **TAMP** terminals of the left-mounted MCX-8, but be sure to do it only after having conducted a "teaching" session (as instructed in the MCR-308 manual, Publication DE3191-).

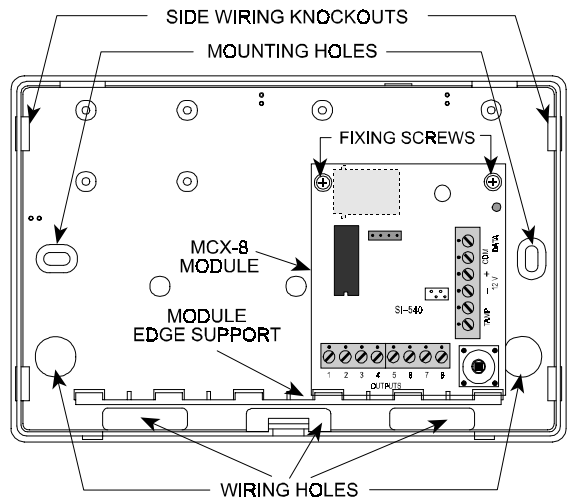

Figure 3. Single MCX-8 Unit within its Cabinet

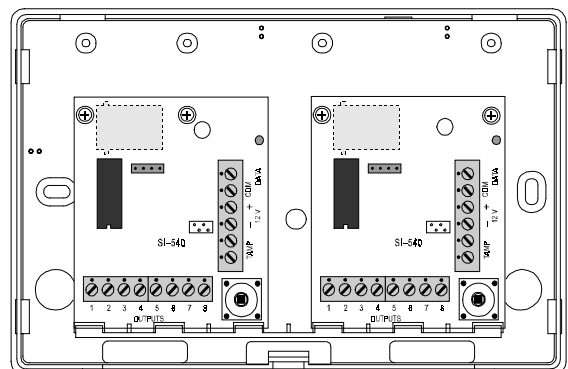

Figure 4. Two MCX-8 units Sharing the Same Cabinet

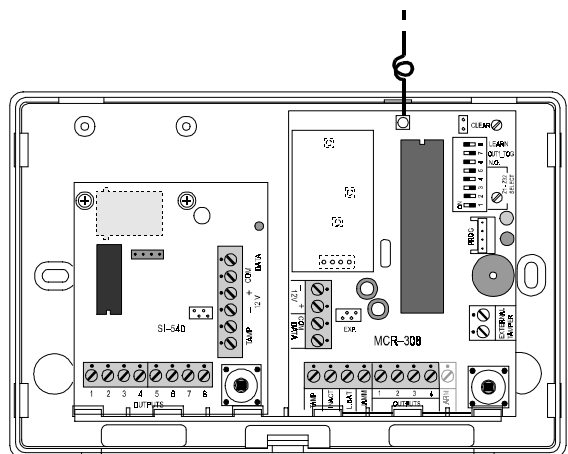

Figure 5. MCR-308 and MCX-8 Sharing the Same Cabinet

## 2. SPECIFICATIONS

**Number of Outputs:** 8, open collector type, 100 mA max. each  
**Unit ID:** 8-bit code  
**Expansion Bus:** 4 wires (+12V, 0V, DATA and COMMON)  
**Bus Length:** Up to 1 km (0.62 miles) with single expander and 100 Ω resistance per wire.  
**Output Polarities:** N.O. or N.C., as set by switch on MCR-308

**Tamper Switch Ratings:** 0.1 A, 30 VDC  
**Input Voltage:** 10 -16 VDC (supplied via the expansion bus).  
**Current Drain:** Approximately 7 mA standby, 13 mA maximum.  
**Operating Temperature Range:** -10°C to 49°C (14°F to 120°F).  
**Size (H x W x D):** 108 x 165 x 38 mm (4-1/4 x 6-1/2 x 1-1/2 in.)  
**Weight (cabinet with single MCX-8):** 191 g (6.75 oz).

## 3. INSTALLATION

### 3.1 Mounting

The MCX-8 is supplied in a plastic cabinet, as described in Para. 1.2. Install the plastic cabinet as follows:

- Remove the screw that secures the cover to the base (Fig. 6).
- Insert a small screwdriver blade into the slot near one of the snap-in tabs, as shown. Carefully flex the cover edge out, until the tab disengages the dent. Repeat this with the other tab.
- Remove the cover and use the mounting and wiring holes as required for the particular installation.

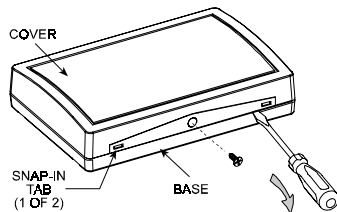

Figure 6. Separating the Cover from the Base

### 3.2 Expansion Bus Hookup

Since the MCR-308 receiver and the MCX-8 expander usually share the same cabinet, the easiest way to link them is to use the short flat cable assembly supplied with each MCX-8 (Figure 7). To continue the bus to additional expanders, use the 4 bus terminals on each unit (refer to Figure 1). Connect each terminal on the bus terminal block to its counterpart on the other unit.

### 3.3 Output Circuit Wiring

After connection via the expansion bus to the MCR-308, the MCX-8 will have a common ground with the control panel via the MCR-308. You only have to connect each output terminal of the MCX-8 to one of the control panel's zone inputs. If the control panel zone inputs are defined as E.O.L., you must use appropriate E.O.L. resistors (see Figure 8).

### 3.4 Using an External Tamper Switch

The built-in tamper switch and the TAMP terminals are connected in parallel. If the external TAMP terminals are used, make sure that

no pressure is applied on the actuating lever of the built-in tamper switch - remove the circular spring if necessary.

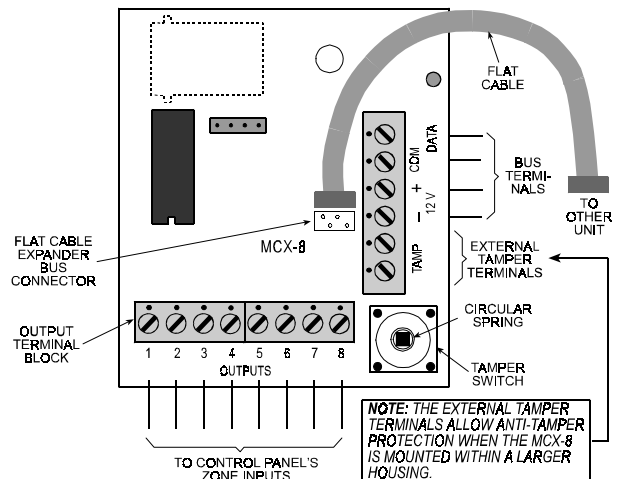

Figure 7. Printed Circuit Board Layout

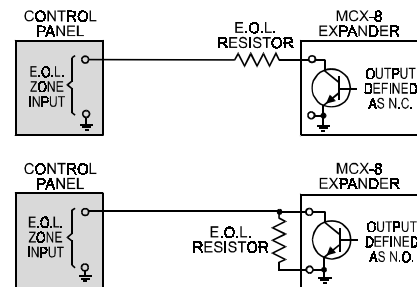

Figure 8. WIRING E.O.L. Zones

## WARRANTY

Visonic Ltd. and/or its subsidiaries and its affiliates ("the Manufacturer") warrants its products hereinafter referred to as "the Product" or "Products" to be in conformance with its own plans and specifications and to be free of defects in materials and workmanship under normal use and service for a period of twelve months from the date of shipment by the Manufacturer. The Manufacturer's obligations shall be limited within the warranty period, at its option, to repair or replace the product or any part thereof. The Manufacturer shall not be responsible for dismantling and/or reinstallation charges. To exercise the warranty the product must be returned to the Manufacturer freight prepaid and insured.

**This warranty does not apply in the following cases:** improper installation, misuse, failure to follow installation and operating instructions, alteration, abuse, accident or tampering, and repair by anyone other than the Manufacturer.

This warranty is exclusive and expressly in lieu of all other warranties, obligations or liabilities, whether written, oral, express or implied, including any warranty of merchantability or fitness for a particular purpose, or otherwise. In no case shall the Manufacturer be liable to anyone for any consequential or incidental damages for breach of this warranty or any other warranties whatsoever, as aforesaid.

This warranty shall not be modified, varied or extended, and the Manufacturer does not authorize any person to act on its behalf in the modification, variation or extension of this warranty. This warranty shall apply to the Product only. All products, accessories or attachments of others used in conjunction with the Product, including batteries, shall be covered solely by their own warranty, if any. The Manufacturer shall not be liable for any damage or loss whatsoever, whether directly, indirectly, incidentally, consequentially or otherwise, caused by the malfunction of the Product due to products, accessories, or attachments of others, including batteries, used in conjunction with the Products.

The Manufacturer does not represent that its Product may not be compromised and/or circumvented, or that the Product will prevent any death, personal and/or bodily injury and/or damage to property resulting from burglary, robbery, fire or otherwise, or that the Product will in all cases provide adequate warning or protection. User understands that a properly installed and maintained alarm may only reduce the risk of events such as burglary, robbery, and fire without warning, but it is not insurance or a guarantee that such will not occur or that there will be no death, personal damage and/or damage to property as a result.

**The Manufacturer shall have no liability for any death, personal and/or bodily injury and/or damage to property or other loss whether direct, indirect, incidental, consequential or otherwise, based on a claim that the Product failed to function.** However, if the Manufacturer is held liable, whether directly or indirectly, for any loss or damage arising under this limited warranty or otherwise, regardless of cause or origin, the Manufacturer's maximum liability shall not in any case exceed the purchase price of the Product, which shall be fixed as liquidated damages and not as a penalty, and shall be the complete and exclusive remedy against the Manufacturer.

**Warning:** The user should follow the installation and operation instructions and among other things test the Product and the whole system at least once a week. For various reasons, including, but not limited to, changes in environmental conditions, electric or electronic disruptions and tampering, the Product may not perform as expected. The user is advised to take all necessary precautions for his /her safety and the protection of his/her property.

6/91



VISONIC LTD. (ISRAEL): P.O.B 22020 TEL-AVIV 61220 ISRAEL. PHONE: (972-3) 645-6789, FAX: (972-3) 645-6788  
 VISONIC INC. (U.S.A.): 10 NORTHWOOD DRIVE, BLOOMFIELD CT. 06002-1911. PHONE: (860) 243-0833, (800) 223-0020 FAX: (860) 242-8094  
 VISONIC LTD. (UK): FRASER ROAD, PRIORY BUSINESS PARK, BEDFORD MK44 3WH. PHONE: (0870) 730-0800 FAX: (0870) 730-0801  
 INTERNET: www.visonic.com

©VISONIC LTD. 1999 MCX-8 DE4050- (REV. 1, 12/99)



MADE IN ISRAEL